

M12 male 0° / RJ45 male 0° shielded Ethernet

PUR 1x4xAWG26 shielded gn UL/CSA+drag chain 3m

Male straight – male straight

M12 – RJ45, 4-pole

D-coded

shielded

Ethernet CAT5

Further cable lengths on request.

Plastic housings with good resistance against chemicals and oils.

The resistance to aggressive media should be individually tested for your application. Further details on request.

Illustration

Product may differ from Image

Approvals

* only for products with UL/CSA approved cable

More Info

EtherNet/IP

**Form**

Form 44711

Cables

No./diameter of wires	1 × 4 × 0.15 mm ²
Wire isolation	PO (wh, ye, bl, or)
C-track properties	5 Mio.
Material (jacket)	PUR (UL/CSA)
Outer Ø	4.9 mm ±5%
Bend radius (moving)	12 × outer Ø
Temperature range (fixed)	-20...+80 °C
Temperature range (mobile)	-20...+50 °C

Cable identification	791
Approval (cable)	UL (AWM-Style 20236/1589), CSA; CE
Cable weight [g/m]	59,40
Material (wire)	Cu wire, bare
Resistor (core)	max. 139.3 Ω /km (20 °C)
Single wire \varnothing (core)	0.15 mm
Construction (core)	19× 0.15 mm (multi-strand wire class 5)
Diameter (core)	1 × 4× AWG26
AWG	similar to AWG 26
Material (wire isolation)	PO
Wire- \varnothing incl. isolation	1.0 mm \pm 5%
Color/numbering of wires	wh, or, bl, ye
Stranding combination	4 wires twisted
Shield	yes
	min. 85%
Material (jacket)	PUR
Material property (jacket)	CFC-, halogen-, cadmium-, silicone- and lead-free
Outer- \varnothing (jacket)	4.9 mm \pm 5%
Color (jacket)	green
chemical resistance	good resistance to oil, gasoline and chemicals
thermal resistance	flame retardant
Temperature range (fixed)	-20...+80 °C
Temperature range (mobile)	-20...+50 °C
Bend radius (fixed)	7.5× outer \varnothing
Bend radius (moving)	12× outer \varnothing
No. of bending cycles (C-track)	max. 5 Mio. (25 °C)
Traversing distance (C-track)	max. 5 m (horizontal)
Travel speed (C-track)	max. 300 m/min
Acceleration (C-track)	max. 5 m/s ²
Jacket Color	green

Technical Data

Operating voltage	max. 60 V DC
Operating voltage (only UL listed)	max. 30 V DC
Rated surge voltage	1.0 kV
Operating current per contact	max. 1.5 A (20 °C)
Material group	IEC 60664-1, category I
Transfer parameters	CAT5, Class D (ISO/IEC 11801:2002), (EN 50173-1)
Transfer rate	up to 100 Mbit/s full duplex
Coding	M12, D-coded
Locking of ports	Screw thread (M12×1 mm) recommended torque 0.6 Nm, self-securing
Compression gland	M12 (SW13)
Protection	IP67 (M12) - IP20 (RJ45)
Locking material	Zinc die casting, matte nickel plated
Material	PUR
suitable for corrugated tube (internal \varnothing)	without

General data

Standards	DIN EN 61076-2-101 (M12)
Pollution Degree	3
Temperature range	-25...+85 °C, depending on cable quality

Commercial data

country of origin	DE
customs tariff number	85444290
EAN	4048879750189
eClass	27061801
Packaging unit	1

Sketch

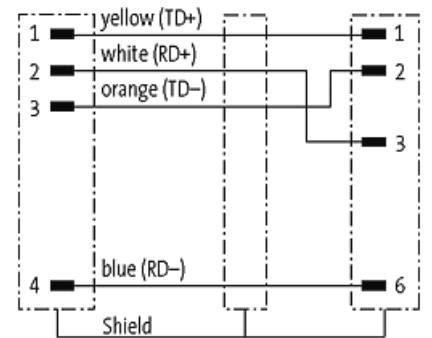
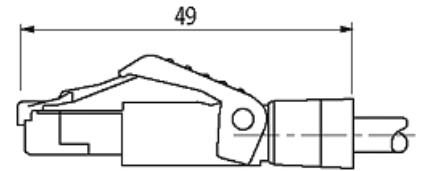

Male

Male

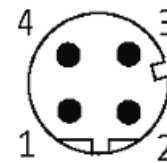

Product may differ from Image